

ORDONANȚĂ DE URGENȚĂ nr. 195 din 12 decembrie 2002

privind circulația pe drumurile publice**)

EMITENT  **Guvernul**Publicat în **Monitorul Oficial nr 670 din data 03-08-2006****Data intrării în vigoare 01-09-2020****Formă consolidată valabilă la data 15-09-2020****Prezenta formă consolidată este valabilă începând cu data de 01-09-2020 până la data de 15-09-2020**

Atenție, se afișează forma consolidată a ORDONANȚĂ DE URGENȚĂ nr. 195 din 12 decembrie 2002(Republicata 1) din Monitorul Oficial nr.670 din 03-08-2006

[Anexa nr. 2](#)

+40 720 528 028



legis@legistm.ro



www.legistm.ro

INDICATOARE RUTIERE

A. INDICATOARE DE AVERTIZARE



Curbă la stânga



Curbă la dreapta



Curbă dublă sau o succesiune de mai mult de două curbe, prima la stânga



Curbă dublă sau o succesiune de mai mult de două curbe, prima la dreapta



Curbă deosebit de periculoasă



Panouri succesive pentru curbe deosebit de periculoase



Coborâre periculoasă



Urcare cu inclinare mare



Drum îngustat pe ambele părți

















Drum îngustat pe partea dreaptă

















Drum îngustat pe partea stângă













Acostament periculos

 <p>Drum aglomerat</p>	 <p>Tunel</p>	 <p>Pod mobil</p>
 <p>Ieșire spre un chei sau mal abrupt</p>	 <p>Drum cu denivelari</p>	 <p>Denivelare pentru limitarea vitezei</p>
 <p>Drum lunecos</p>	 <p>Improșcare cu pietriș</p>	 <p>Căderi de pietre</p>
 <p>Presemnalizare trecere pietoni</p>	 <p>Copii</p>	 <p>Bicicliști</p>
 <p>Animale</p>	 <p>Animale</p>	 <p>Lucrări</p>

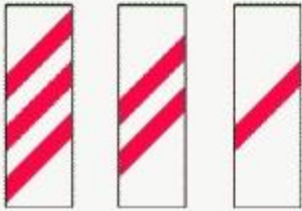
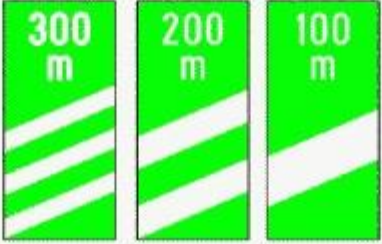
		
Semafoare	Acroport	Vânt lateral
		
Circulație în ambele sensuri	Alte pericole	Accident
		
Intersecție de drumuri	Intersecție cu un drum fără prioritate	Intersecție cu un drum fără prioritate
		
Intersecție cu un drum fără prioritate	Intersecții cu drumuri fără prioritate, decalate	Intersecții cu drumuri fără prioritate, decalate
		
Presemnalizare intersecție cu sens giratoriu	Trecere la nivel cu o cale ferată cu bariere sau semibariere	Trecere la nivel cu o cale ferată fără bariere

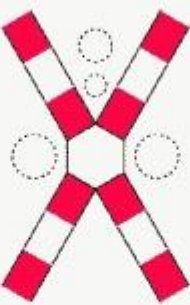

 <p>Trecere la nivel cu linii de tramvai</p>	 <p>Mașini și utilaje agricole</p>	 <p>Presemnalizarea unei amenajări rutiere care oferă și posibilitatea întoarcerii vehiculelor</p>
 <p>Baliză direcțională care indică ocolirea obstacolului prin stânga</p>	 <p>Baliză direcțională care indică ocolirea obstacolului prin dreapta</p>	 <p>Baliză bidirecțională</p>
 <p>Panouri suplimentare pentru trecerea la nivel cu calea ferată</p>	 <p>Panouri suplimentare la nodurile rutiere de pe autostrăzi</p>	 <p>Trecere la nivel cu o cale ferată simplă, fără bariere</p>
 <p>Trecere la nivel cu o cale ferată dublă, fără bariere</p>	 <p>Trecere la nivel cu o cale ferată simplă fără bariere</p>	 <p>Trecere la nivel cu o cale ferată dublă fără bariere</p>

B. INDICATOARE DE REGLEMENTARE

B1. Indicatoare de prioritate



Cedează trecerea



Oprire



Drum cu prioritate



Sfârșitul drumului cu prioritate



Prioritate pentru circulația din sens invers



Prioritate față de circulația din sens invers

B2. Indicatoare de interzicere sau restricție

















Accesul interzis

































Circulația interzisă în ambele sensuri



Accesul interzis autovehiculelor cu excepția motocicletelor fără ataș







 <p>Accesul interzis motocicletelor</p>	 <p>Accesul interzis bicicletelor</p>	 <p>Accesul interzis ciclomotoarelor</p>
 <p>Accesul interzis vehiculelor destinate transportului de mărfuri</p>	 <p>Accesul interzis autovehiculelor cu remorcă, cu excepția celor cu semiremorcă sau cu remorcă cu o osie</p>	 <p>Accesul interzis autobuzelor</p>
 <p>Accesul interzis pietonilor</p>	 <p>Accesul interzis vehiculelor cu tracțiune animală</p>	 <p>Accesul interzis vehiculelor împinse sau trase cu mâna</p>
 <p>Accesul interzis tractoarelor și mașinilor autopropulsate pentru lucrări</p>	 <p>Accesul interzis autovehiculelor</p>	 <p>Accesul interzis autovehiculelor și vehiculelor cu tracțiune animală</p>
 <p>Accesul interzis vehiculelor cu lățimea mai mare de ... m</p>	 <p>Accesul interzis vehiculelor cu înălțimea mai mare de ... m</p>	 <p>Accesul interzis vehiculelor cu masa mai mare de ... t</p>

 <p>Accesul interzis vehiculelor cu masa mai mare de ... t pe osia simplă</p>	 <p>Accesul interzis vehiculelor cu masa pe osia dublă mai mare de ... t</p>	 <p>Accesul interzis vehiculelor cu masa pe osia triplă mai mare de ... t</p>
 <p>Accesul interzis autovehiculelor sau ansamblurilor de vehicule cu lungimea mai mare de ... m</p>	 <p>Interzis autovehiculelor de a circula fără a menține între ele un interval de cel puțin ... m</p>	 <p>Interzis a vira la stânga</p>
 <p>Interzis a vira la dreapta</p>	 <p>Întoarcerea interzisă</p>	 <p>Depășirea autovehiculelor, cu excepția motocicletelor fără ataș, interzisă</p>
 <p>Depășirea interzisă autovehiculelor destinate transportului de mărfuri</p>	 <p>Limitare de viteză</p>	 <p>Limitare de viteză diferențiată pe categorii de autovehicule</p>
 <p>Claxonarea interzisă</p>	 <p>Vama</p>	 <p>Taxă de trecere</p>

 <p>Control POLIȚIE</p>	 <p>Sfârșitul tuturor restricțiilor</p>	 <p>Sfârșitul limitării de viteză</p>
 <p>Sfârșitul interzicerii de a depăși</p>	 <p>Staționarea interzisă</p>	 <p>Oprirea interzisă</p>
 <p>Staționare alternantă</p>	 <p>Staționare alternantă</p>	 <p>Zona de staționare cu durată limitată</p>
 <p>Sfârșitul zonei de staționare cu durată limitată</p>	 <p>Zonă cu viteza limitată la 30 km/h</p>	 <p>Sfârșitul zonei cu viteza limitată la 30 km/h</p>
 <p>Accesul interzis vehiculelor care transportă substanțe explozive sau ușor inflamabile</p>	 <p>Accesul interzis vehiculelor care transportă mărfuri periculoase</p>	 <p>Accesul interzis vehiculelor care transportă substanțe de natură să polueze apele</p>

B3. Indicatoare de obligare

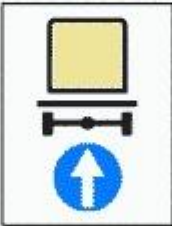









 <p>Înainte</p>	 <p>La dreapta</p>	 <p>La dreapta</p>
 <p>Înainte sau la dreapta</p>	 <p>Ocolire</p>	 <p>Ocolire</p>
 <p>Intersecție cu sens giratoriu</p>	 <p>Pistă pentru biciclete</p>	 <p>Drum obligatoriu pentru categoria de vehicule</p>
 <p>Drum pentru pietoni</p>	 <p>Delimitarea pistelor pentru pietoni și biciclete</p>	 <p>Delimitarea pistelor pentru pietoni și biciclete</p>









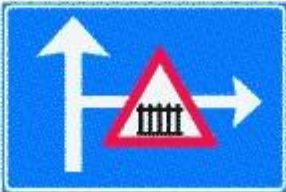
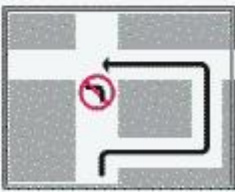



 <p>Pistă comună pentru pietoni și biciclete</p>	 <p>Viteza minimă obligatorie</p>	 <p>Sfârșitul vitezei minime obligatorii</p>
 <p>Lanțuri pentru zăpadă</p>	 <p>Direcția obligatorie pentru vehiculele care transportă mărfuri periculoase</p>	 <p>Direcția obligatorie pentru vehiculele care transportă mărfuri periculoase</p>
 <p>Direcția obligatorie pentru vehiculele care transportă mărfuri periculoase</p>		



C. INDICATOARE DE ORIENTARE ȘI INFORMARE

C1. Indicatoare de orientare

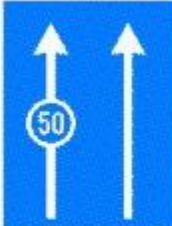
 <p>Presemnalizarea direcțiilor la o intersecție de drumuri din afara localităților</p>	 <p>Presemnalizarea direcțiilor la o intersecție denivelată de drumuri</p>	 <p>Presemnalizarea direcțiilor indicate</p>
 <p>Presemnalizarea traseului de evitare a localității</p>	 <p>Presemnalizarea direcțiilor într-o intersecție cu sens giratoriu</p>	 <p>Drum închis sau deschis circulației publice</p>
 <p>Presemnalizarea traseului de urmat în cazul unei restricții de circulație</p>	 <p>Presemnalizare pe autostradă pentru parcare</p>	 <p>Presemnalizare pe autostradă pentru spațiu de servicii</p>
 <p>Confirmarea direcției de mers pe autostradă spre localități mai importante și distanțele până la acestea</p>	 <p>Presemnalizarea unui loc periculos, o interzicere sau o restricție pe un drum lateral</p>	 <p>Presemnalizarea traseului de urmat în vederea efectuării virajului la stânga</p>

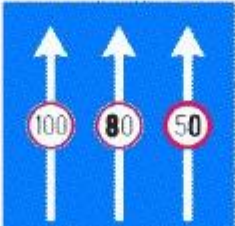
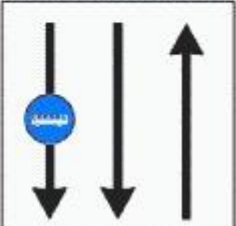
 <p>Bandă rezervată circulației autovehiculelor de transport public de persoane</p>	 <p>Drum fără ieșire</p>	 <p>Traseu de urmat pentru anumite categorii de vehicule</p>
 <p>Traseu de urmat pentru anumite categorii de vehicule</p>	 <p>Traseu de urmat pentru anumite categorii de vehicule</p>	 <p>Selectarea circulației pe direcții de mers în apropierea intersecției</p>
 <p>Selectarea circulației pe direcții de mers în apropierea intersecției</p>	 <p>Selectarea circulației pe direcții de mers în apropierea intersecției</p>	 <p>Bandă destinată circulației vehiculelor lente</p>
 <p>Terminarea benzii de circulație din dreapta a părții carosabile</p>	 <p>Terminarea benzii de circulație din stânga a părții carosabile</p>	 <p>Viteza minimă obligatorie pentru o bandă de circulație</p>
 <p>Viteza minimă obligatorie pentru diferite benzi de circulație</p>	 <p>Limite de viteză pentru diferite benzi de circulație</p>	 <p>Bandă de circulație rezervată autovehiculelor de transport public de persoane</p>













 <p>Direcția spre localitatea indicată</p>	 <p>Direcția spre localitatea indicată</p>	 <p>Direcția spre localitățile indicate</p>
 <p>Direcția de urmat pentru autovehiculele destinate transportului de mărfuri</p>	 <p>Direcția spre obiectivul turistic</p>	 <p>Direcția spre obiective locale</p>
 <p>Direcția spre aeroport</p>	 <p>Direcția de urmat în cazul devierii temporare a circulației</p>	 <p>Direcția de urmat în cazul devierii temporare a circulației</p>
 <p>Drum național</p>	 <p>Drum județean</p>	 <p>Drum comunal</p>
 <p>Drum deschis traficului internațional</p>	 <p>Direcția drumului deschis traficului internațional</p>	 <p>Traseu de tranzit european</p>















 <p>Simbolul și numărul autostrăzii</p>	 <p>Intrare în localitate</p>	  <p>Intrare în localitate</p>
 <p>Ieșire din localitate</p>	  <p>Ieșire din localitate</p>	 <p>Limită de județ</p>
 <p>Curs de apă sau viaduct</p>	 <p>Confirmarea direcției de mers spre o localitate și distanța până la aceasta</p>	 <p>Confirmarea direcției de mers spre localități mai importante și distanțele până la acestea</p>
 <p>Organizarea traficului pe benzi de circulație</p>	 <p>Telefon de urgență (Poliție, Ambulanță, Pompieri, Depanare)</p>	





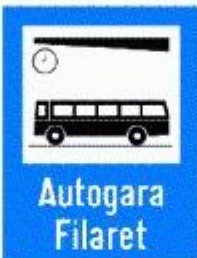



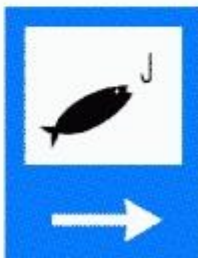

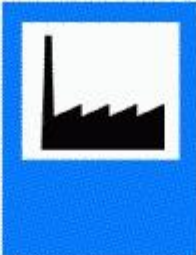



C2. Indicatoare de informare

 <p>Trecere pentru pietoni</p>	 <p>Trecere pentru pietoni</p>	 <p>Limite generale de viteză</p>
 <p>Sens unic</p>	 <p>Sens unic</p>	 <p>Autostradă</p>
 <p>Sfârșit de autostradă</p>	 <p>Limite maxime de viteză pe autostradă, funcție de condițiile meteorologice</p>	 <p>Spital</p>
 <p>Poliția</p>	 <p>Post de prim-ajutor</p>	 <p>Pasarelă pentru pietoni</p>







 <p>Pasaj subteran pentru pietoni</p>	 <p>Stație de autobuz</p>	 <p>Stație de tramvai</p>
 <p>Stație de taximetre</p>	 <p>Drum pentru autovehicule</p>	 <p>Sfârșitul drumului pentru autovehicule</p>
 <p>Vulcanizare</p>	 <p>Telefon</p>	 <p>Stație de alimentare cu carburanți</p>
 <p>Stație de alimentare cu carburanți inclusiv benzină fără plumb</p>	 <p>Stație de alimentare cu carburanți inclusiv benzină fără plumb și gaz petrolier lichefiat</p>	 <p>Hotel sau motel</p>
 <p>Restaurant</p>	 <p>Bufet sau cofetărie</p>	 <p>Teren pentru camping (tabără turistică)</p>

 <p>Teren pentru caravane (tabără turistică)</p>	 <p>Teren pentru camping și caravane</p>	 <p>Loc pentru popas</p>
 <p>Cabană pentru turiști</p>	 <p>W.C. public</p>	 <p>Service auto</p>
 <p>Parcare</p>	 <p>Parcare</p>	 <p>Parcare subterană sau în clădire</p>
 <p>Complex de servicii</p>		 <p>Zonă rezidențială</p>
		 <p>Sfârșitul zonei rezidențiale</p>

 <p>Zonă cu viteză recomandată 30 km/h</p>	 <p>Sfârșitul zonei cu viteză recomandată 30 km/h</p>	 <p>Zonă pietonală</p>
 <p>Sfârșitul zonei pietonale</p>	 <p>Tunel</p>	 <p>Sfârșit de tunel</p>
 <p>Îmbarcare pe vagoane platformă de cale ferată</p>	 <p>Îmbarcare pe ferry-boat</p>	 <p>Port</p>
 <p>Gară</p>	 <p>Autogară</p>	 <p>Închirieri auto</p>
 <p>Plajă</p>	 <p>Zonă de vânatoare</p>	 <p>Zonă de pescuit</p>

 Centru viticol	 Zonă industrială	 Poșta 200m
 200m Apă potabilă	 Loc de joacă pentru copii	 Stadionul Steaua Stadion
 BILLA 100 m Supermarket	 Acces internet	 Teatrul Nottara Teatru
 Muzeul Antipa Muzeu	 Cântar pentru autovehicule	 Radar Control radar
 INFO TRAFIC 100,1 MHz Radio Vacanta Informații rutiere	 Viteza recomandată	 Punct de informare turistică



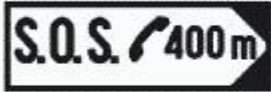











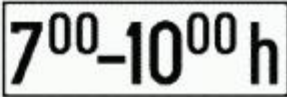







<p>str. Dragoș Vodă</p> <p>Denumirea străzii</p>	<p>str. Dragoș Vodă ></p> <p>Intrarea pe strada indicată</p>	<p>70</p> <p>Numărul imobilului</p>
 <p>Monitorizare trafic</p>	 <p>Refugiu rezervat depănării</p>	 <p>Presemnalizarea sediului Poliției autostrăzii</p>
 <p>Distanța de siguranță între vehicule pentru viteze de cel mult 60 km/h</p>	 <p>Distanța de siguranță între vehicule pentru viteze mai mari de 60 km/h</p>	 <p>Tichet</p> <p>Acces pe bază de tichet</p>
 <p>Direcția și distanța până la telefonul pentru apel de urgență</p>		

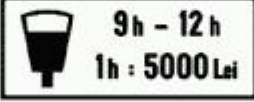









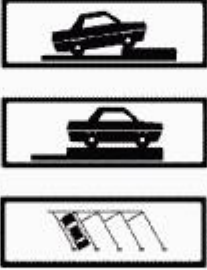

C3. Indicatoare de informare turistică

 <p>Castelul Bran</p> <p>Castel, cetate</p>	 <p>Histria</p> <p>Vestigii istorice</p>	 <p>Mausoleul Mărășești</p> <p>Monument</p>
 <p>Biserica Trei Ierarhi</p> <p>Biserică</p>	 <p>Mănăstirea Cașin</p> <p>Mănăstire</p>	 <p>Rezervația Rodna</p> <p>Rezervație naturală</p>
 <p>Cascada Bălea</p> <p>Cascadă</p>	 <p>Pestera Muierii</p> <p>Peșteră</p>	 <p>Pârția Clăbucet</p> <p>Pârție schi</p>
 <p>200 m</p> <p>Teleschi</p>	 <p>←</p> <p>Telecabină</p>	 <p>Pensiunea Ana Maria</p> <p>Pensiune agroturistică</p>

D. PANOURI ADIȚIONALE

 <p>Distanța până la locul la care se referă indicatorul de presemnalizare sau informare</p>	 <p>Distanța între indicator și începutul locului periculos</p>	 <p>Direcția și distanța până la locul la care se referă indicatorul</p>
 <p>Persoane cu handicap</p>	 <p>Intervalele de timp în care acționează indicatorul</p>	 <p>Intervalele de timp în care acționează indicatorul</p>
 <p>Trecere la nivel cu cale ferată industrială completând semnificația indicatorului "Alte pericole"</p>	 <p>Lungimea sectorului periculos la care se referă indicatorul</p>	 <p>Începutul și lungimea zonei de acțiune a indicatorului</p>
 <p>Începutul zonei de acțiune a indicatorului</p>	 <p>Confirmarea zonei de acțiune a indicatorului</p>	 <p>Sfârșitul zonei de acțiune a indicatorului</p>

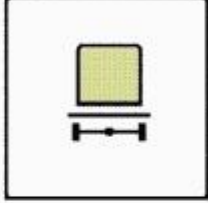
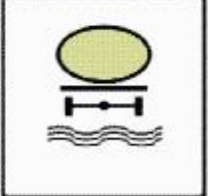
 <p>Categoria de autovehicule la care se referă indicatorul</p>	 <p>Categoriile de autovehicule care trebuie să respecte semnificația indicatorului</p>	 <p>Folosirea luminilor de întâlnire</p>
 <p>Parcare cu plată</p>	 <p>Parcare cu plată</p>	 <p>Exceptarea unor categorii de vehicule de la semnificația indicatorului</p>
 <p>Intervalele de timp când este permisă staționarea vehiculelor ce efectuează aprovizionarea</p>	 <p>Drum închis circulației publice</p>	 <p>Trecere pentru pietoni desființată</p>
 <p>Cu excepția riveranilor</p>	 <p>Cu excepția autovehiculelor autorizate</p>	 <p>Autovehiculul se ridică</p>
 <p>Viteza recomandată pe un sector de drum cu semafoare sincronizate</p>	 <p>Direcția drumului cu prioritate</p>	 <p>Direcția drumului cu prioritate</p>

 <p>Sensul sau sensurile de circulație pentru care este valabilă semnificația semnalelor luminoase ale semaforului</p>	 <p>Trecerea la nivel cu calea ferată prevăzută cu instalație de semnalizare luminoasă automată</p>	 <p>Rampă pentru persoane cu handicap locomotor</p>
 <p>Modalități în care se execută parcare</p>	 <p>Modalități în care se execută parcare</p>	 <p>Ridicare autovehicule parcate neregulamentar</p>
 <p>Folosirea luminilor de întâlnire</p>	 <p>Polei, gheață, zăpadă</p>	 <p>Duș</p>
 <p>Ploaic, ceață, viscol</p>	 <p>Vehicle care transportă substanțe explozive sau ușor inflamabile</p>	 <p>Vehicle care transportă mărfuri periculoase</p>
 <p>Vehicle care transportă substanțe de natură să polueze apele</p>	 <p>Distanța până la indicatorul "Oprire"</p>	 <p>Numărul nodului rutier de pe autostradă</p>

DISPOZITIVE DE SEMNALIZARE LUMINOASĂ

1. Semafoare pentru dirijarea circulației



Semafor



Semafoare cu indicarea direcției de deplasare

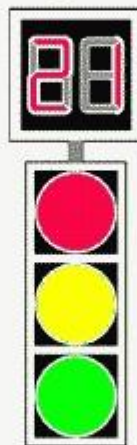

Semafor combinat cu dispozitiv de cronometrare a timpului aferent culorii



Semafor cu panou de contrast



Semafor pentru biciclete



Semafor pentru pietoni



Semafor pentru pietoni combinat cu dispozitiv de cronometrare a timpului aferent culorii



Semafor de avertizare

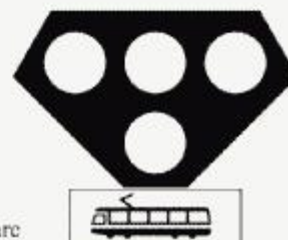

Semafor special pentru tramvaie

2. Semnale luminoase la trecerile la nivel cu calea ferată



Trecere la nivel cu o cale ferată simplă, fără bariere, prevăzută cu semnale luminoase de avertizare a apropierii trenului



Trecere la nivel cu o cale ferată dublă, fără bariere, prevăzută cu semnale luminoase de avertizare a apropierii trenului



Trecere la nivel cu o cale ferată simplă cu semibarieră, prevăzută cu semnale luminoase de avertizare a apropierii trenului

INDICATOR KILOMETRIC



Autostradă

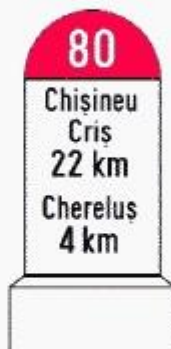

Drum național



Drum județean

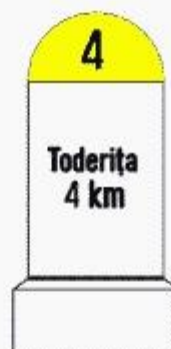













Drum comunal















INDICATOR HECTOMETRIC



INDICATOARE RUTIERE ȘI MIJLOACE DE SEMNALIZARE A LUCRĂRIILOR ÎN ZONA DRUMULUI PUBLIC

1. Indicatoare rutiere temporare

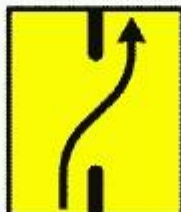
 <p>Drum îngustat pe ambele părți</p>	 <p>Drum îngustat pe partea dreaptă</p>	 <p>Drum îngustat pe partea stângă</p>
 <p>Acostament periculos</p>	 <p>Drum cu denivelări</p>	 <p>Drum lunecos</p>
 <p>Împrôșcare cu pietriș</p>	 <p>Lucrări</p>	 <p>Semafoare</p>
 <p>Circulație în ambele sensuri</p>	 <p>Alte pericole</p>	 <p>Depașirea autovehiculelor, cu excepția motocicletelor fără ataș, interzisă</p>

 <p>Limitare de viteză</p>	 <p>Sfârșitul tuturor restricțiilor</p>	 <p>Sfârșitul interzicerii de a depăși</p>
 <p>Deviere temporară</p>	 <p>Deviere temporară</p>	 <p>Deviere temporară</p>
 <p>Deviere temporară</p>	 <p>Denivelare față de banda alăturată</p>	 <p>Îngustare temporară</p>
 <p>Îngustare temporară</p>	 <p>Abateră temporară</p>	 <p>Abateră temporară</p>
 <p>Abateră temporară</p>	 <p>Terminarea abaterii temporare</p>	 <p>Îngustare temporară</p>

 <p>Îngustare temporară</p>	 <p>Presemnalizarea rutei ocolitoare 500 m</p>	 <p>Ocolire 200 m</p> <p>Presemnalizarea rutei ocolitoare</p>
 <p>Ploiești 200 m</p> <p>Presemnalizarea rutei ocolitoare</p>	 <p>SE APLICA MARCAJE</p> <p>40</p> <p>Marcaje rutiere</p>	 <p>Semnalizarea unui utilaj care se deplasează lucrând</p>
 <p>DRUM IN LUCRU</p> <p>40</p> <p>↑ 7km ↑</p> <p>Succesiune de puncte de lucru</p>	 <p>PERICOL DE ACCIDENTE</p> <p>400 m</p> <p>Presemnalizarea unui sector cu circulație alternantă</p>	 <p>PERICOL DE ACCIDENTE</p> <p>400 m</p> <p>Presemnalizarea unui sector cu circulație alternantă</p>
 <p>PERICOL de spargere a parbrizelor</p> <p>Reduceti viteza</p> <p>40</p> <p>NU depășiți</p> <p>Păstrați distanța</p> <p>Lucrări de tratamente ale suprafeței părții carosabile</p>	 <p>Presemnalizare lucrări pe străzi</p>	

2. Mijloace auxiliare de semnalizare a lucrărilor

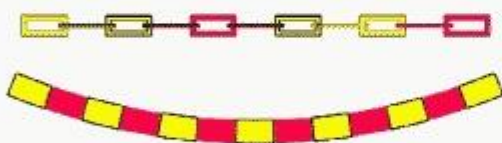

Ghirlandă polietilenă sau lanț

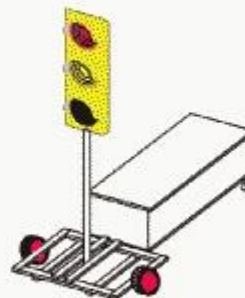

Semafor mobil



Baliză direcțională care indică ocolirea obstacolului prin stânga



Baliză direcțională care indică ocolirea obstacolului prin dreapta

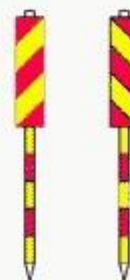

Baliză tip jalon



Baliză bidirecțională



Con de dirijare



Balize cuplate cu lămpi cu lumină galbenă intermitentă



Lampă cu lumină galbenă intermitentă



Barieră normală



Barieră direcțională



Fanion de semnalizare

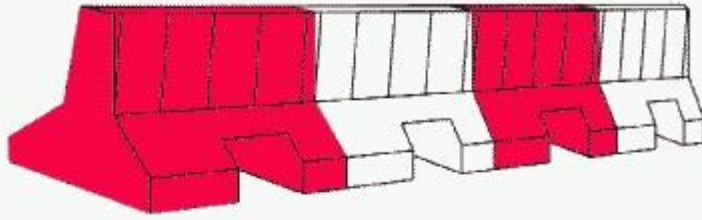

Parapet lestabil din material plastic



Cărucioare portsemnalizare

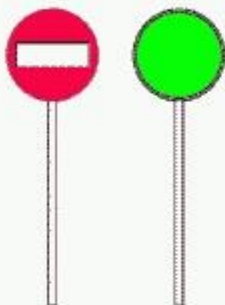

Palete de semnalizare

3. Dispozitive luminoase pentru dirijarea circulației pe benzi

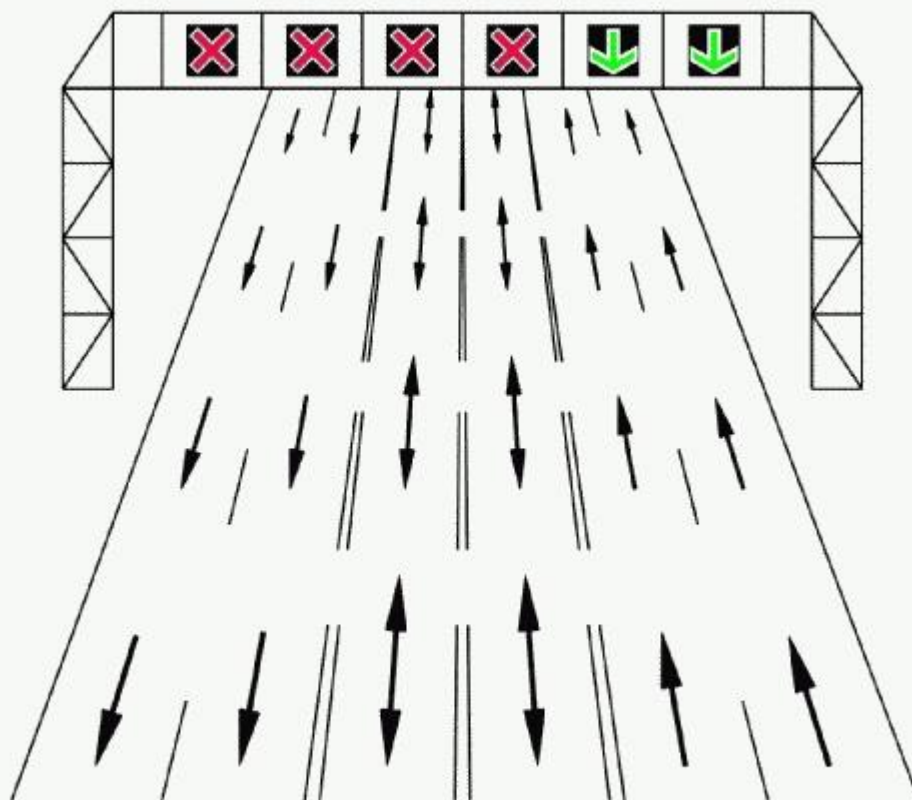
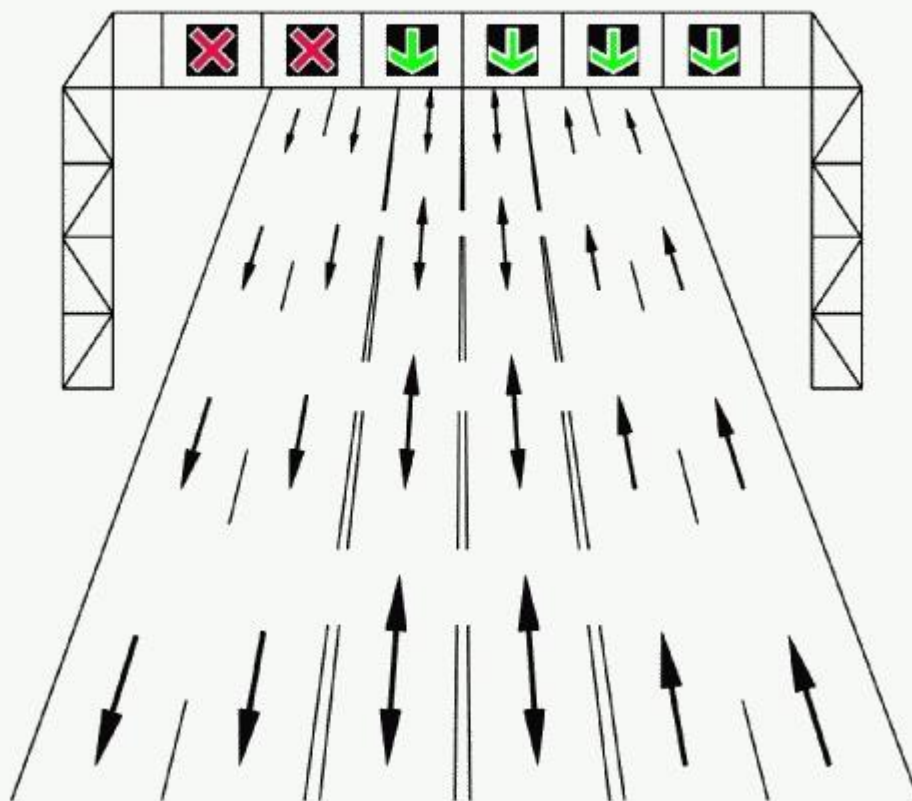

Dispozitive luminoase pentru dirijarea circulației pe benzi reversibile



Panou cu mesaje variabile

MARCAJE RUTIERE

a) Longitudinale

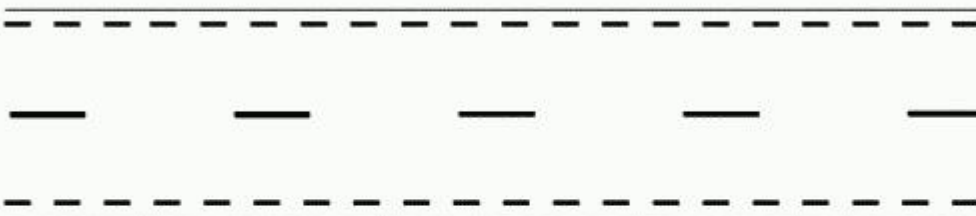

Marcaj de separare a sensurilor de circulație format dintr-o linie discontinuă simplă. Marcaj de delimitare a părții carosabile cu linie discontinuă

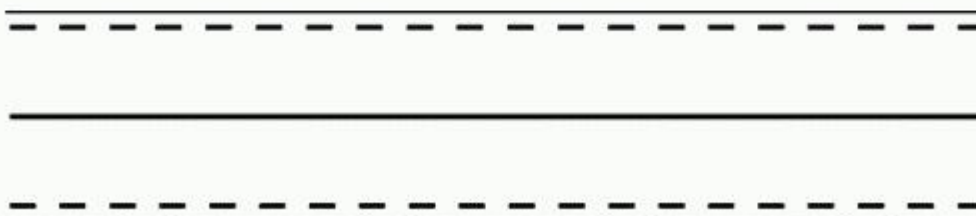

Marcaj de separare a sensurilor de circulație format dintr-o linie continuă simplă. Marcaj de delimitare a părții carosabile cu linie discontinuă

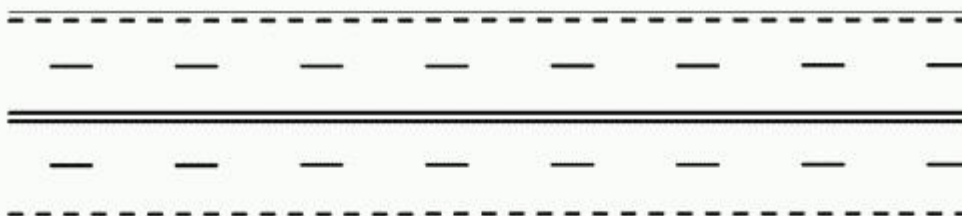

Marcaj de separare a sensurilor de circulație format dintr-o linie continuă dublă. Marcaj de delimitare a benzilor de circulație de același sens cu linie discontinuă. Marcaj de delimitare a părții carosabile cu linie discontinuă

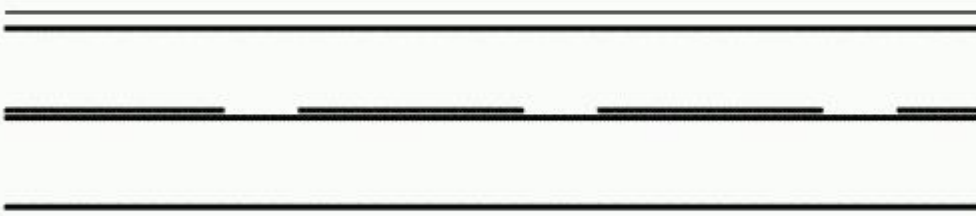

Marcaj de separare a sensurilor de circulație format dintr-o linie continuă, dublată cu una discontinuă. Marcaj de delimitare a părții carosabile cu linie continuă



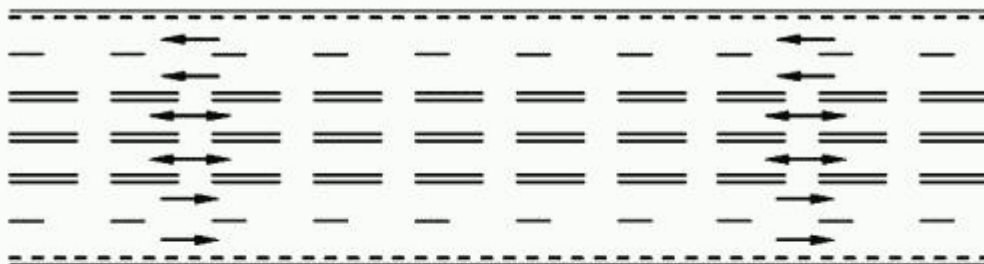

Marcaj pentru benzi cu circulația reversibilă

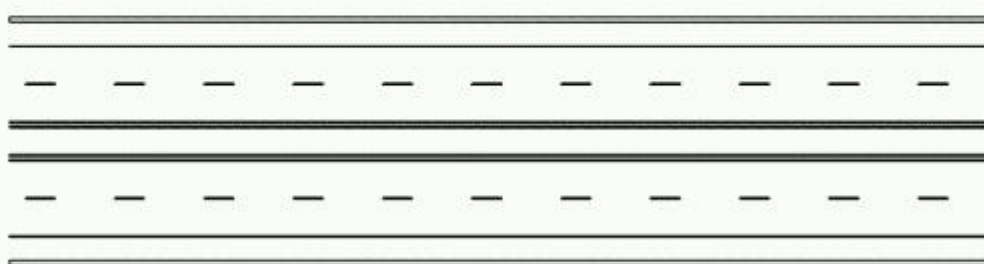

Marcaj pe drumuri cu zona verde de separare a sensurilor de circulație

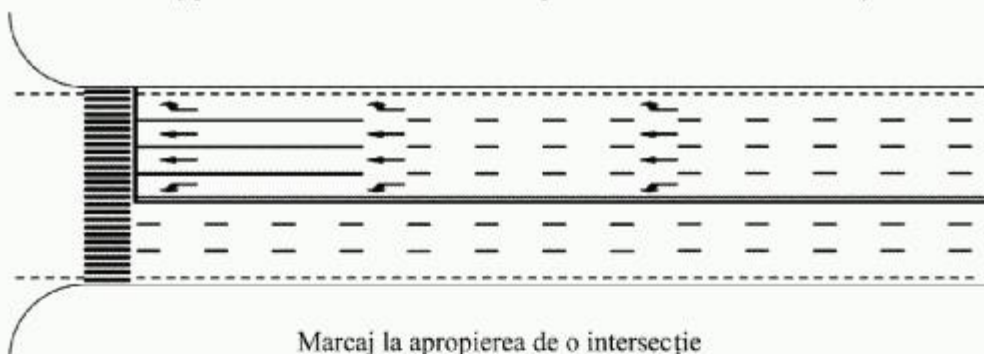

Marcaj la apropierea de o intersecție

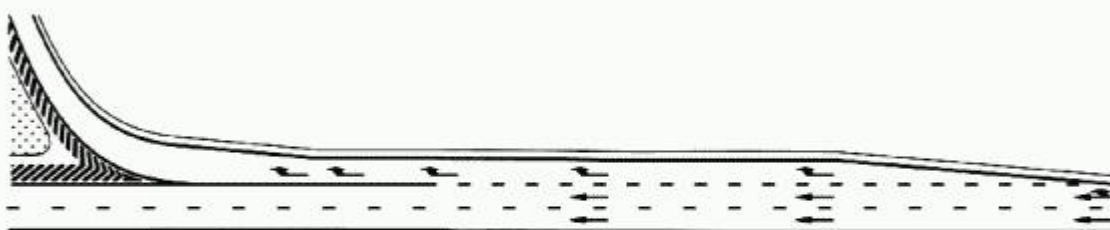

Marcajul pe o bandă de decelerare

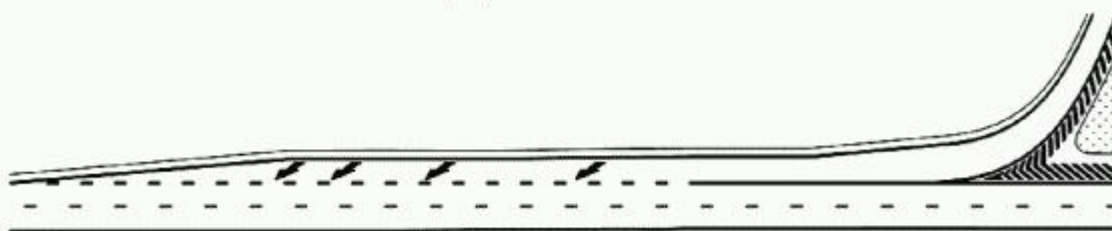

Marcajul pe o bandă de accelerare



Marcajul benzii suplimentare pentru vehicule lente



Marcajul benzii de stocaj pentru virajul la stânga

b) Transversale

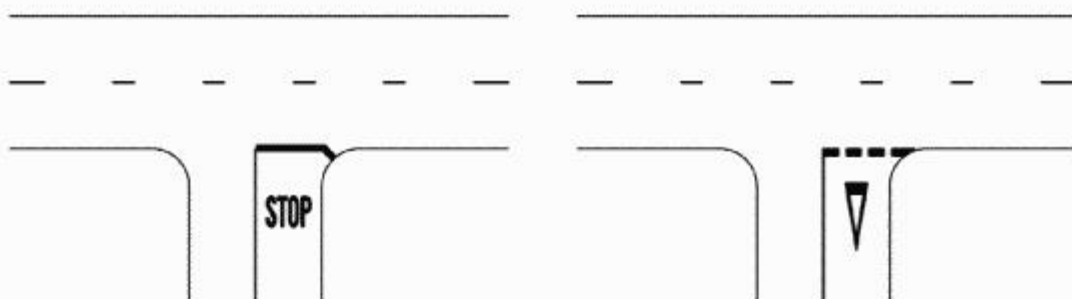

Marcaj de oprire și cedare a trecerii

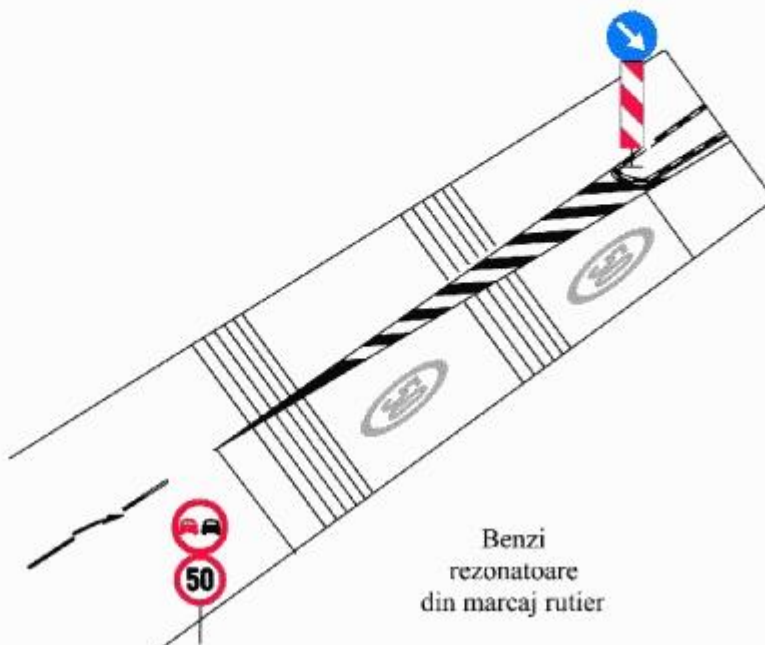

Benzi rezonatoare din marcaj rutier

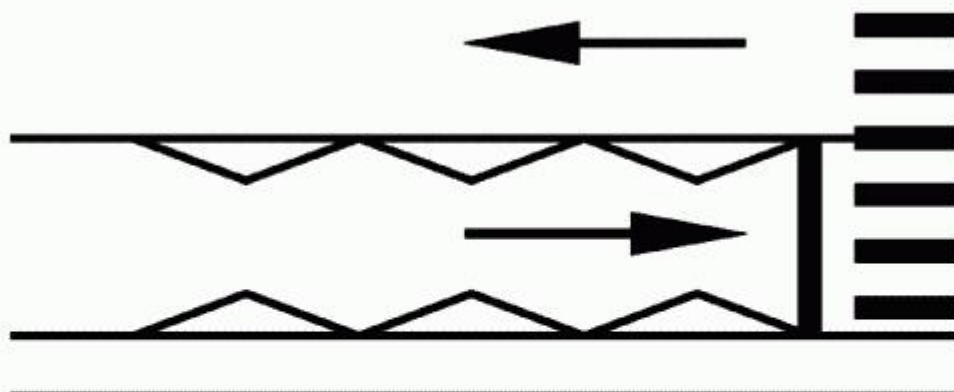
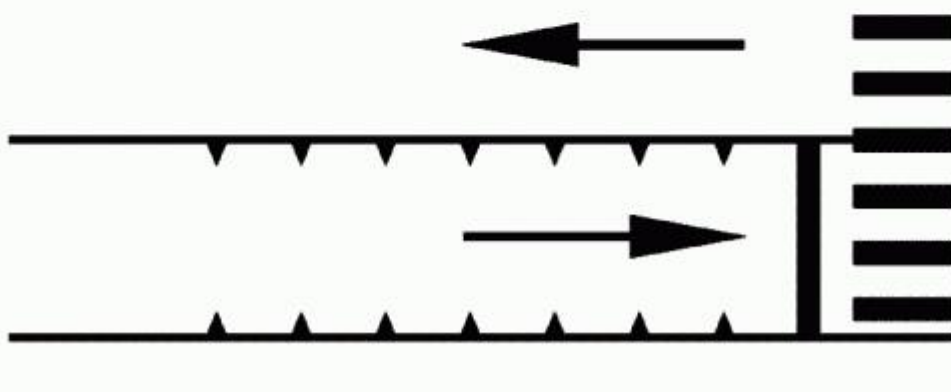
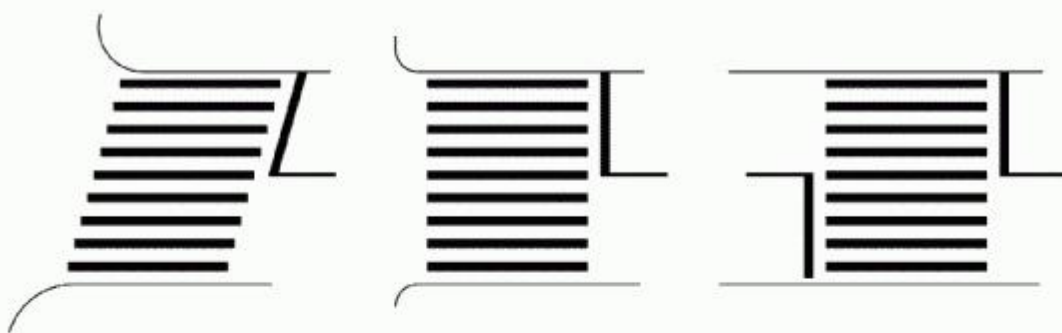

Marcaje de traversare pentru pietoni



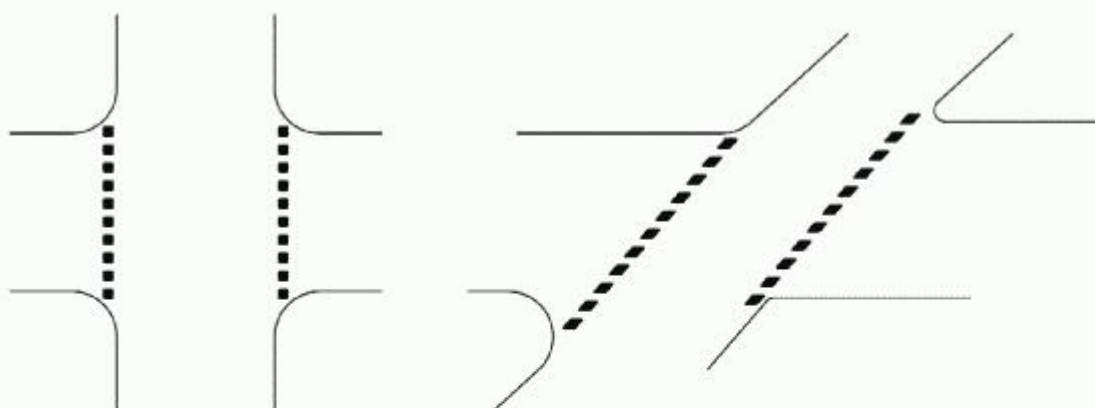

Marcaj de traversare pentru biciclete

c) Diverse

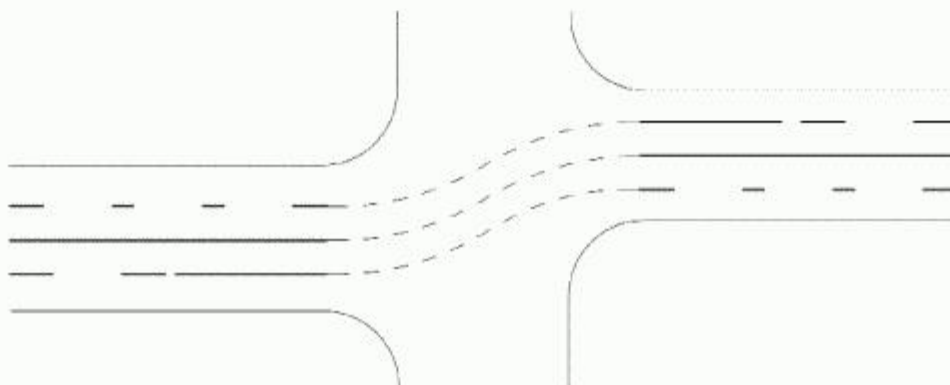

Marcaj de ghidare la traversarea unei intersecții

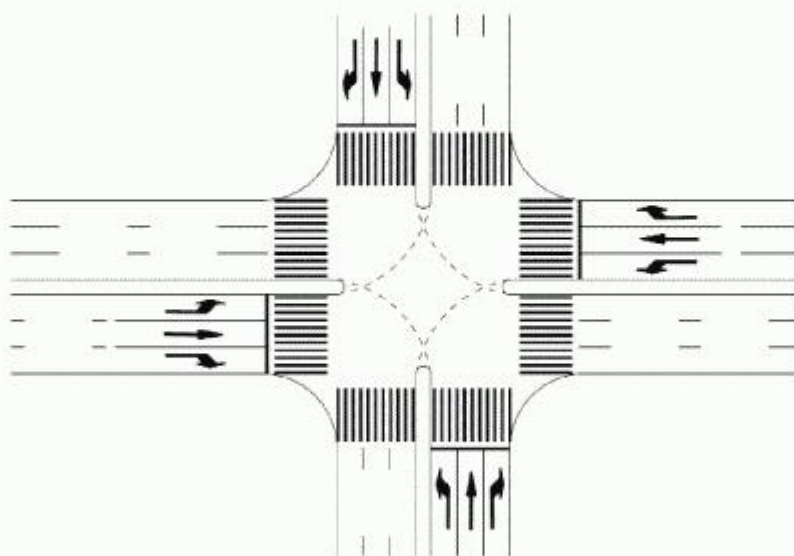

Marcaj de ghidare în intersecție



Marcaj pentru spații înguste



Marcaj la îngustarea drumului cu o bandă pe sens



Marcaj pe drum cu trei benzi pentru alocarea alternativă a doua benzi pentru unul sau celălalt sens de circulație



Spații interzise circulației

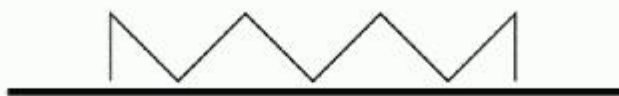

Interzicerea staționării

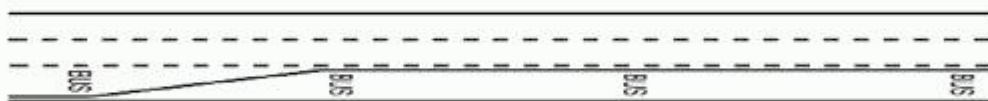

Marcajul benzii rezervate circulației autovehiculelor de transport persoane

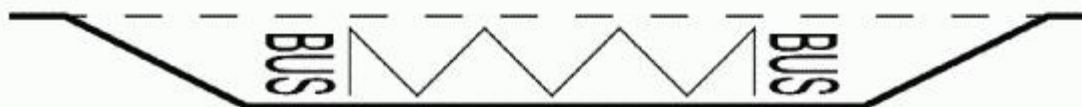

Stație autovehicule de transport persoane

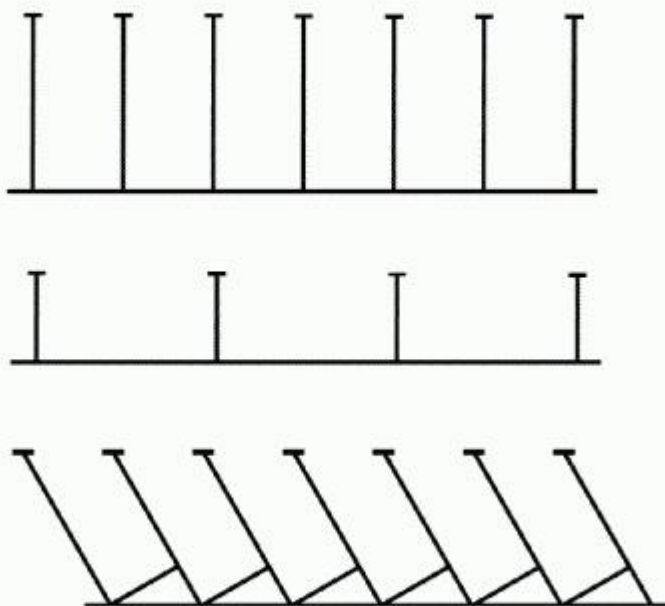

Locuri de parcare

d) Laterale

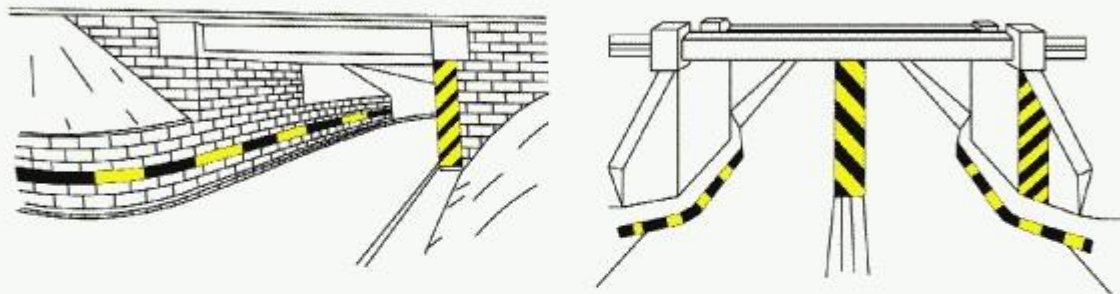

Marcaje pe ziduri de sprijin și pe infrastructurile pasajelor inferioare

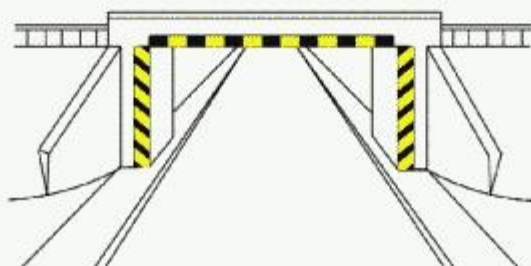

Marcaje la pasaje care nu au asigurat gabaritul de înălțime

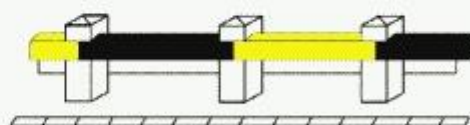
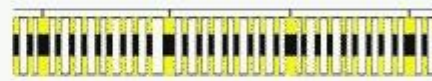
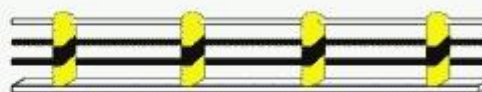
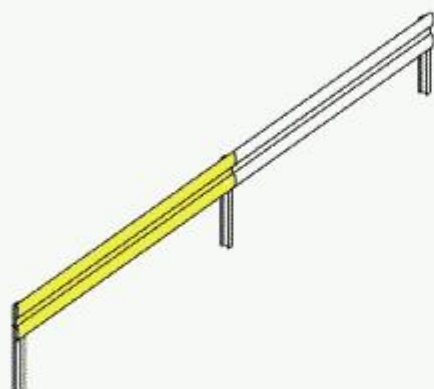

Marcaje pe parapete

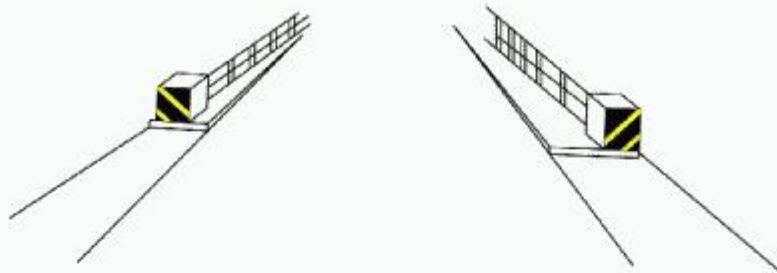

Marcaje pe coronamentele podetelor



Marcaje la refugii pe partea carosabilă

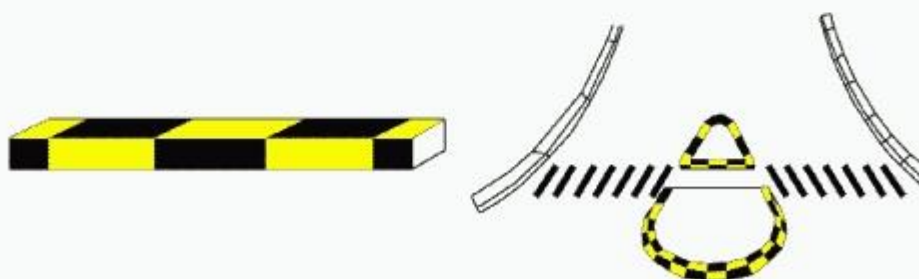

Marcaje pe borduri



Marcaj de interzicere a depășirii
în unele curbe deosebit de periculoase

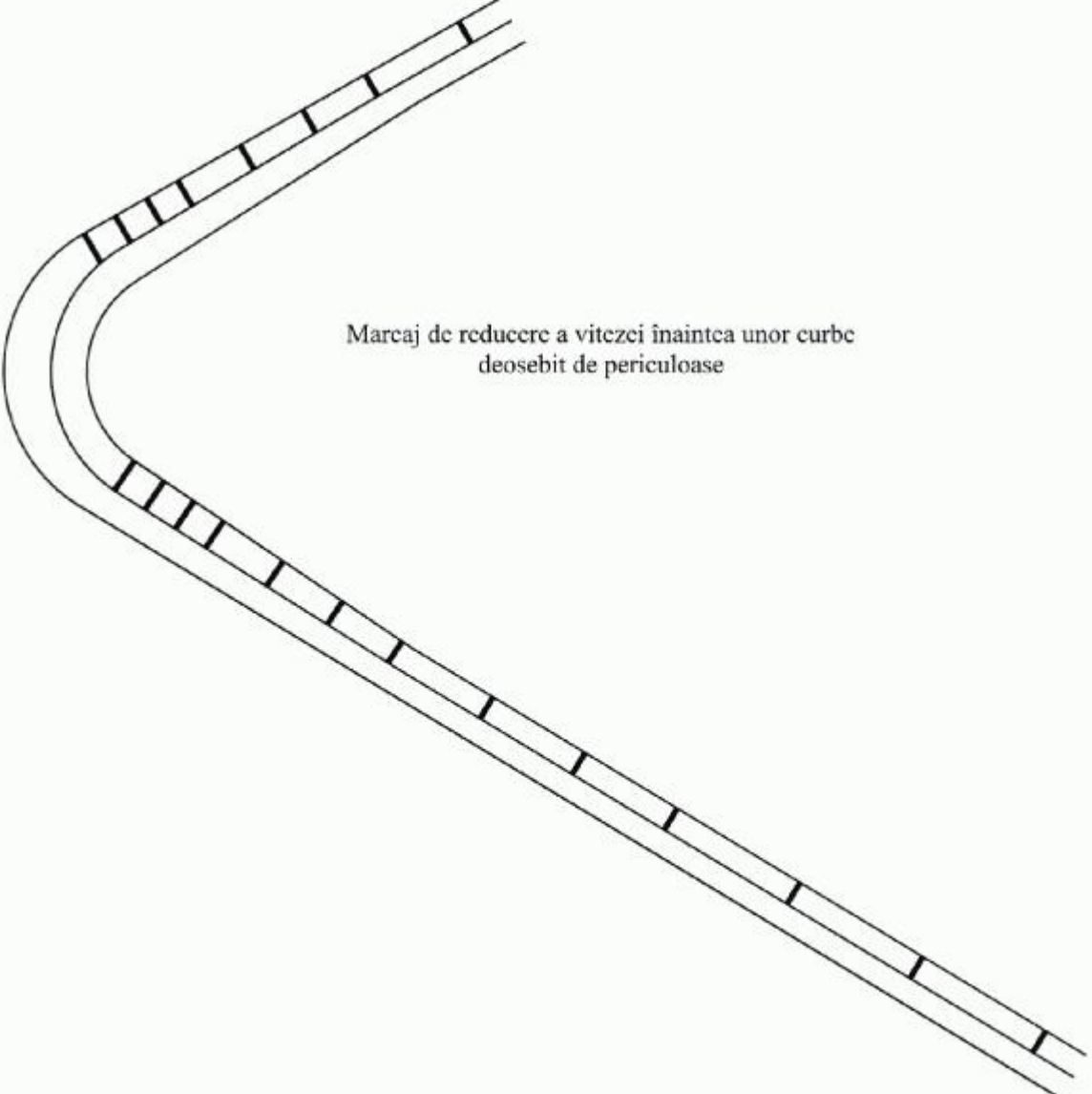

Marcaj de reducere a vitezei înaintea unor curbe
deosebit de periculoase



Săgeți de revenire pe banda aferentă sensului de mers



Săgeți de schimbare a benzii de circulație

**BUS
BRASOV
TAXI**

**E 85
STOP**



Marcaje inscripționate pe partea carosabilă

e) Marcaje temporare pentru semnalizarea lucrărilor în zona drumului public

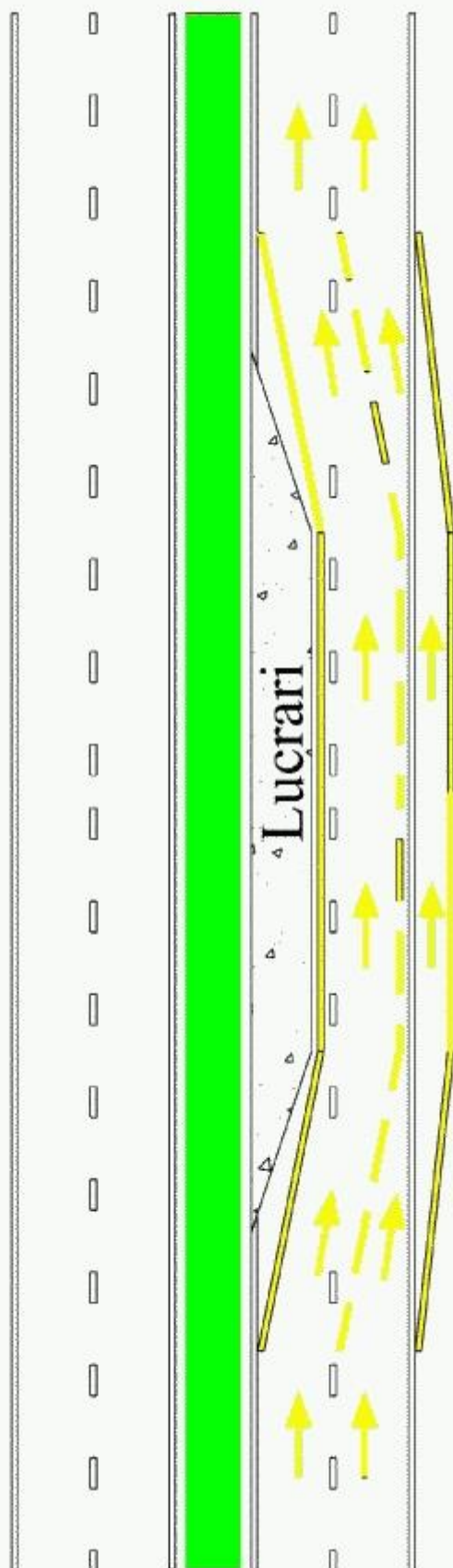

SEMNALELE POLIȚISTULUI



Atenție oprire



Oprire



Oprire



Oprire



Oprire



Măriți viteza



Reduceți viteza



SEMNALELE POLIȚISTULUI DE PE MOTOCICLETA DE POLIȚIE



Oprire



Reduceți viteza



Oprire

SEMNALELE POLIȚISTULUI DIN AUTOVEHICULUL DE POLIȚIE



Oprire



MESAJE VARIABILE TRANSMISE CU DISPOZITIVE LUMINOASE INSTALATE PE AUTOVEHICULELE DE POLIȚIE



Mesajele afișate:

1. STOP POLIȚIA
2. ATENȚIE PERICOL
3. CONCURS SPORTIV
4. MENȚINEȚI ORDINEA
5. ELIBERAȚI ZONA
6. ELIBERAȚI BANDA
7. URMAȚI POLIȚIA
8. GABARIT DEPĂȘIT
9. COLOANĂ OFICIALĂ
10. CONTROL POLIȚIA
11. REDUCEȚI VITEZA
12. ATENȚIE BLOCAJ
13. ATENȚIE ACCIDENT
14. CIRCULAȚI



SEMN DISTINCTIV PENTRU CONDUCĂTORII DE AUTOVEHICULE CU VECHIMEA ÎN CONDUCERE MAI MICĂ DE UN AN



SEMN DISTINCTIV PENTRU CONDUCĂTORUL DE AUTOVEHICUL CU DIZABILITĂȚI DE AUZ



La data de 09-04-2020 **Anexa nr. 2** a fost completată de **Punctul 2, ARTICOLUL UNIC** din **LEGEA nr. 46** din 3 aprilie 2020, publicată în **MONITORUL OFICIAL nr. 287** din 06 aprilie 2020

Conform **art. 2** din **HOTĂRÂREA nr. 1.391** din 4 octombrie 2006, publicată în **MONITORUL OFICIAL nr. 876** din 26 octombrie 2006, anexa la **Ordonanța de urgență a Guvernului nr. 195/2002**, republicată, cu modificările și completările ulterioare, s-a modificat și s-a înlocuit cu anexa nr. 2 la prezenta hotărâre.

Anexa la prezenta ordonanță de urgență a devenit anexa 2 conform pct. 17 al **art. I** din **LEGEA nr. 203** din 9 noiembrie 2012, publicată în **MONITORUL OFICIAL nr. 760** din 12 noiembrie 2012.

Toate drepturile rezervate © 2020 - **iLegis** - SC CTCE SA



+40 720 528 028



legis@legistm.ro



www.legistm.ro